

Acoustic hood/cabinet

Assembly instructions



Acoustic Cabinet Basic page 6
Art no: 2355



Acoustic Hood Everest page 2
Art no: 1250



Acoustic Cabinet Everest v4/v3 page 14
Art no: 2375

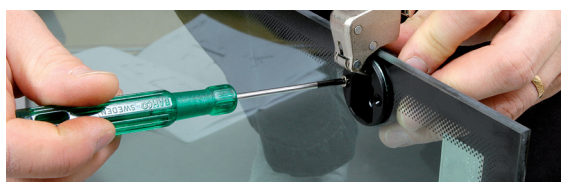

Acoustic Hood Basic page 22
Art no: 1859

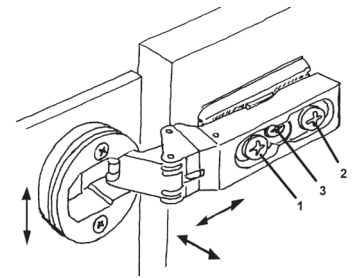
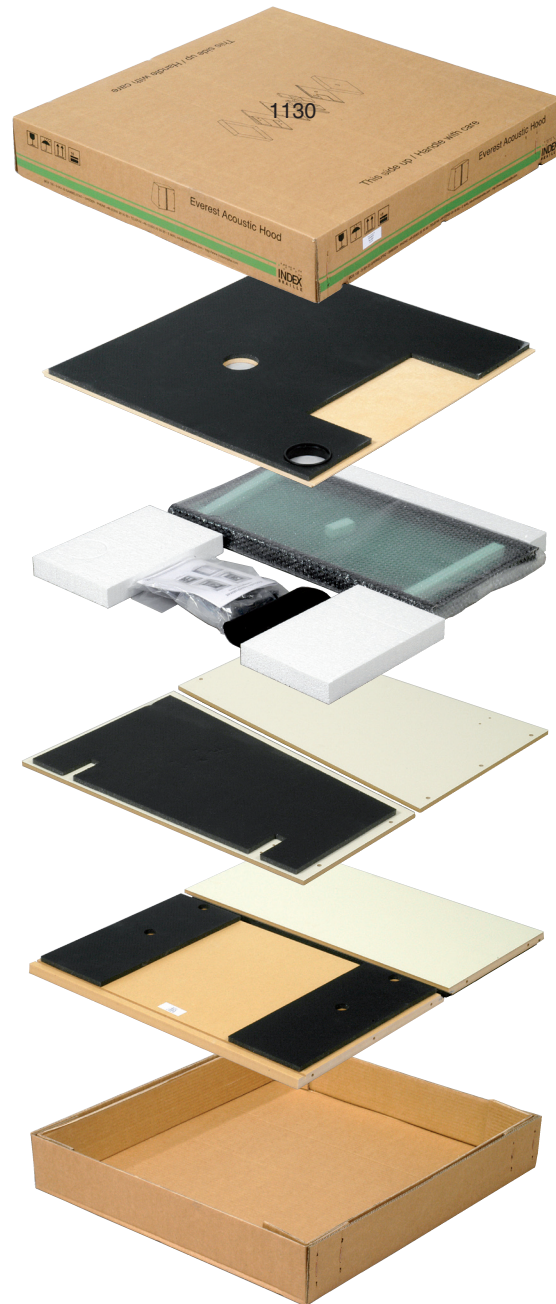

HINGE ADJUSTMENTS

- 1. Side adjustment +/- 2mm
- 2. Depth adjustment +/- 2mm
- 3. Height adjustment +/- 2mm



1505 (x10)



1582 (x8)



1580 (x8)



1584 (x8)



1586 (x4)



1581 (x1)



2031 (x1)

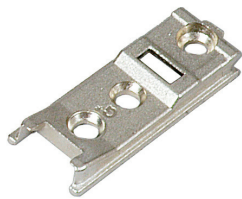

1585 (x4)



1587 (x4)



1588 (x1)

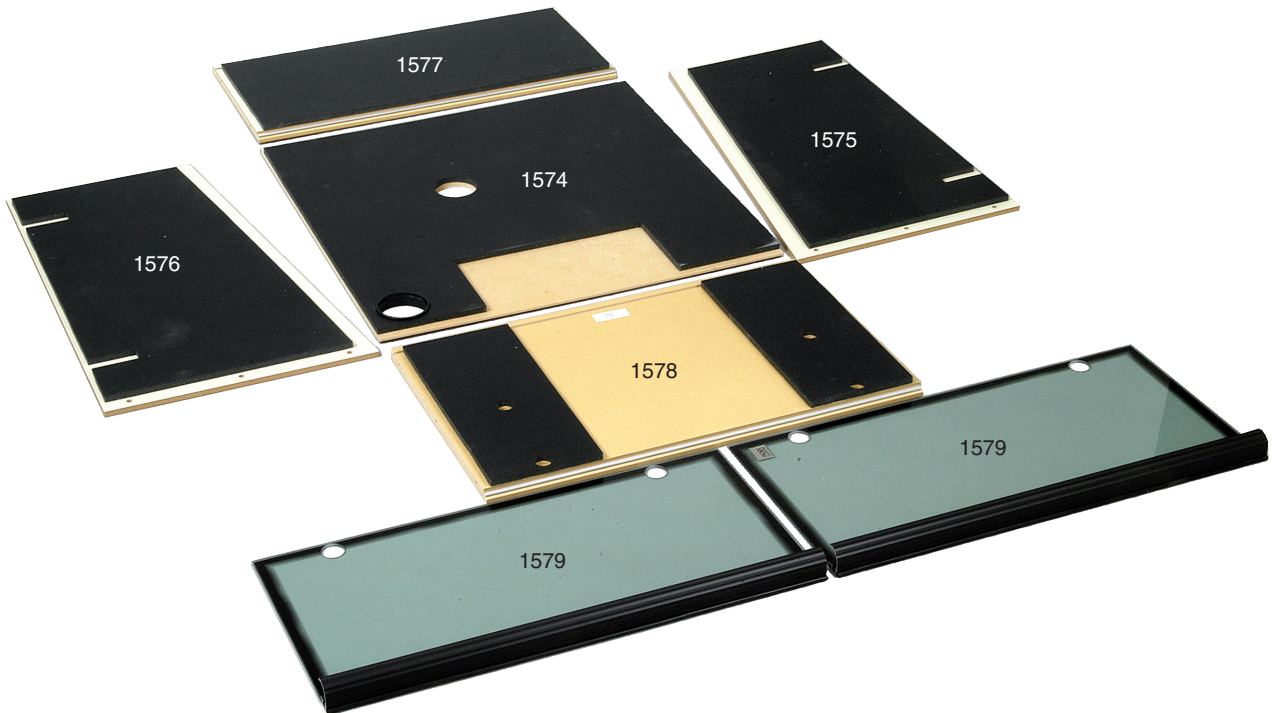



1



2



3



4



5



6

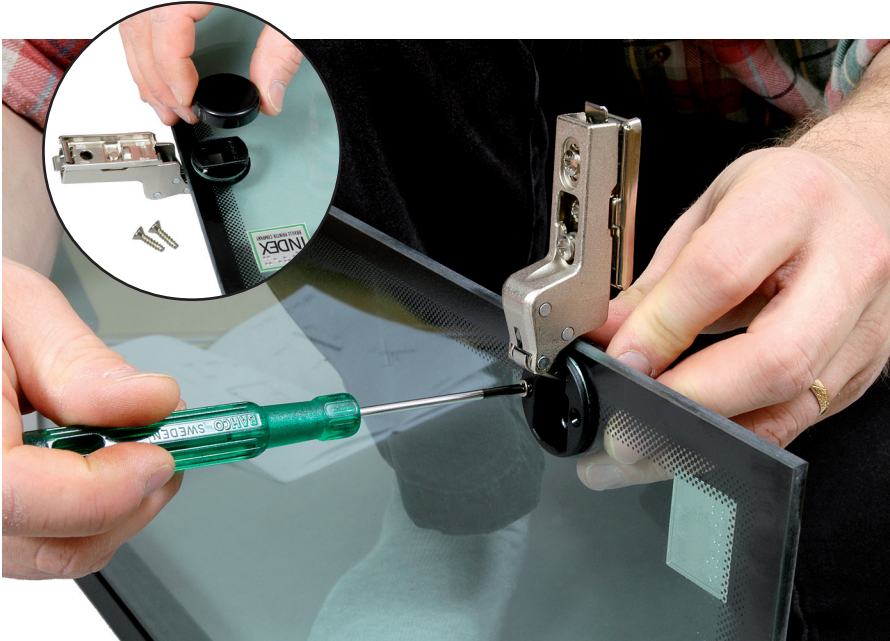
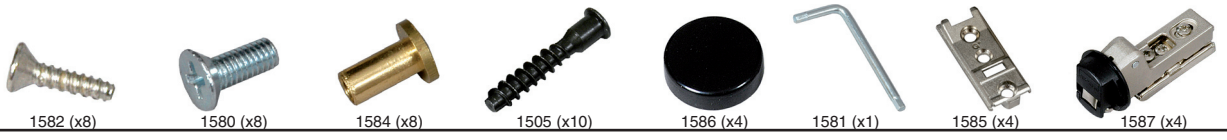

7



8



9



10



11



Basic Acoustic Cabinet. Art no: 2355

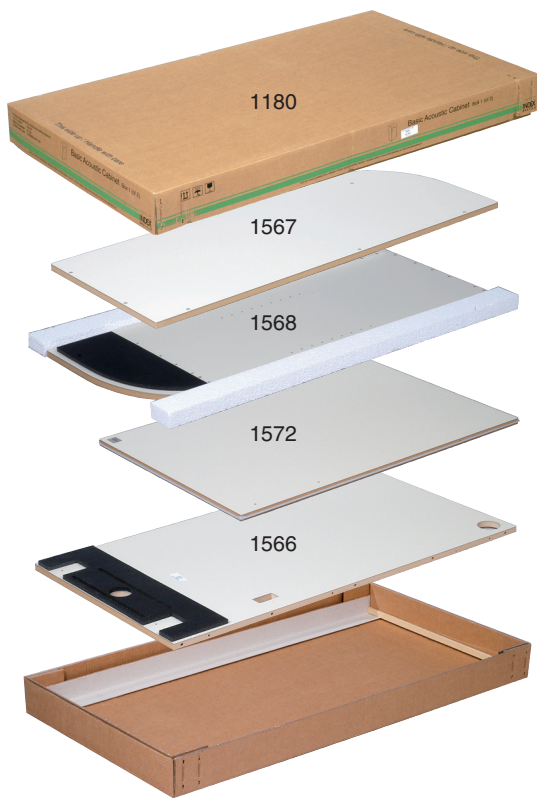

Box 1 of 2

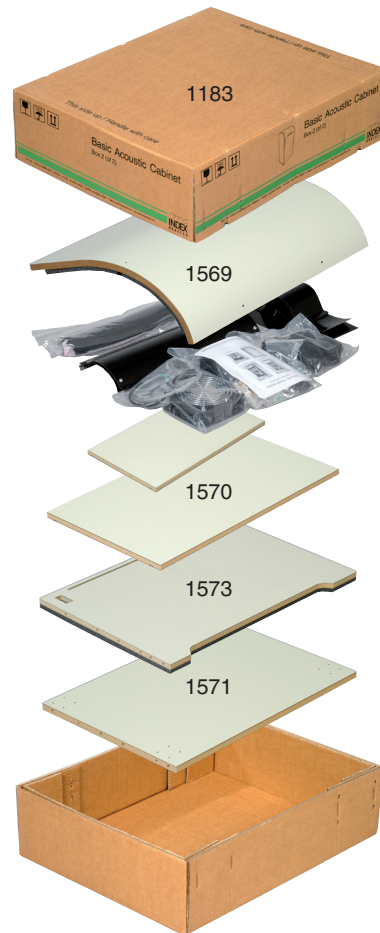

Box 2 of 2

Parts included

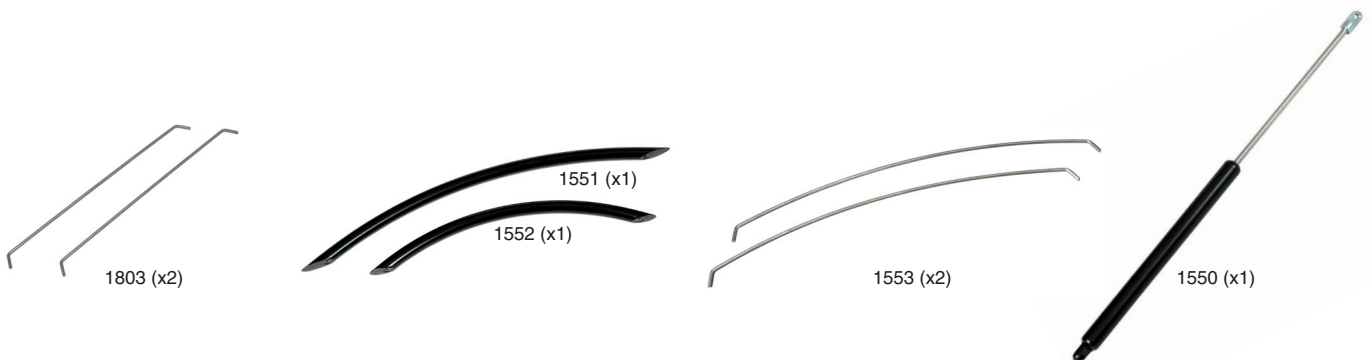
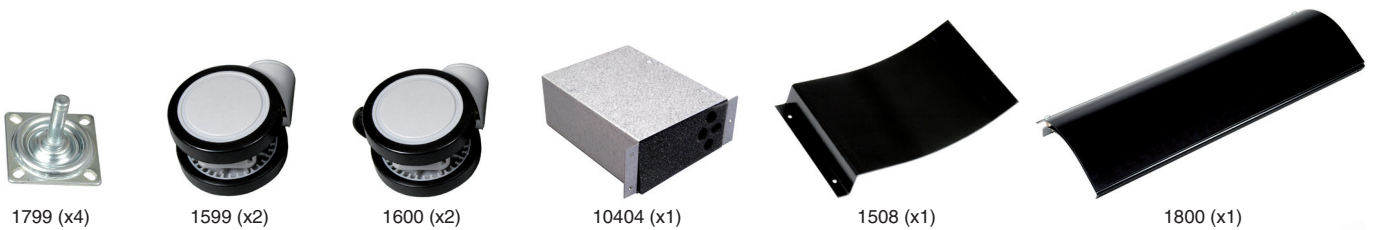
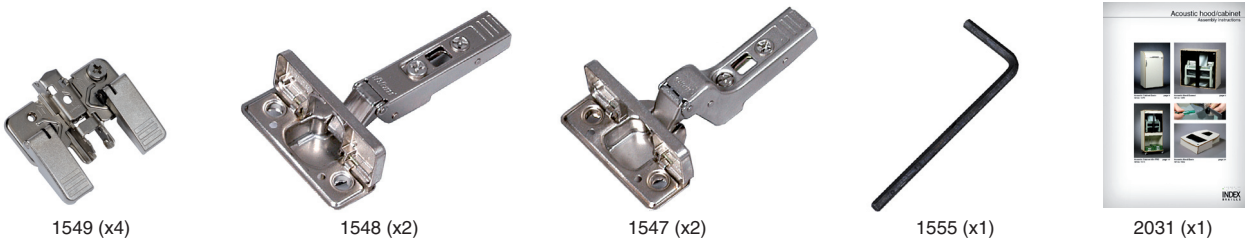
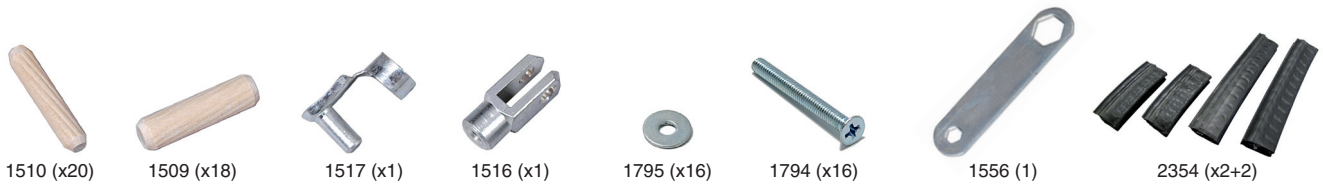



Basic Acoustic Cabinet. Art no: 2355



1



2



3



4

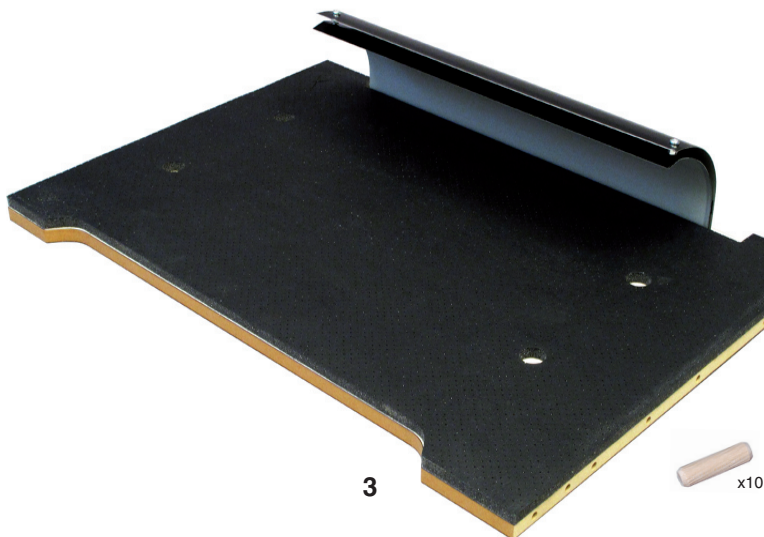
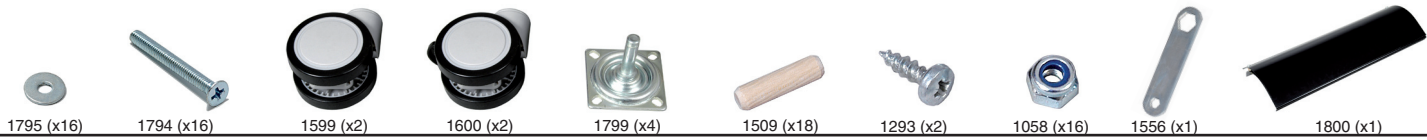



Basic Acoustic Cabinet. Art no: 2355

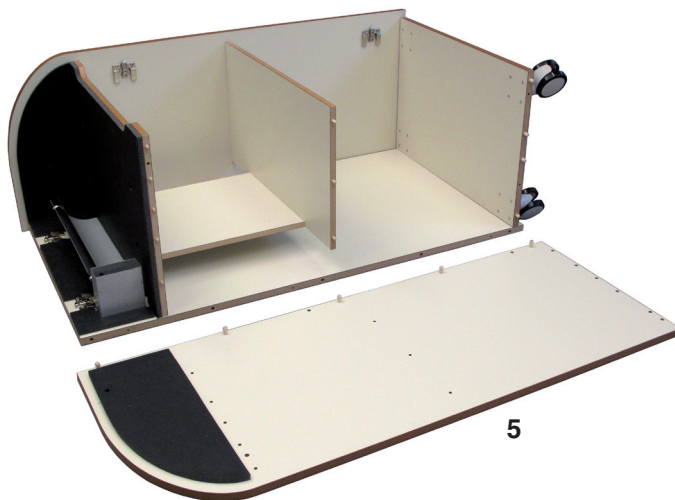
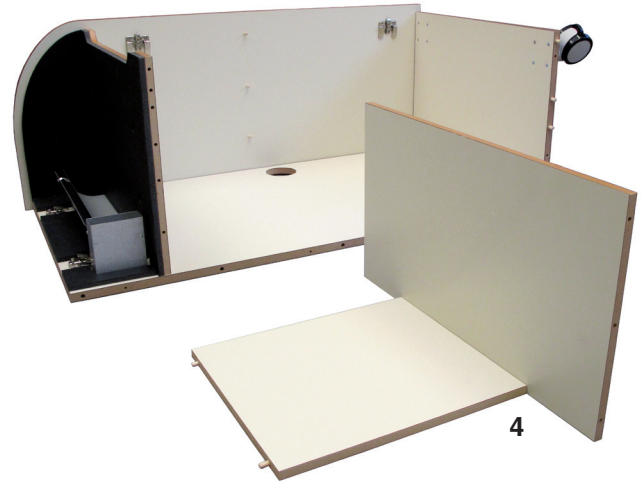
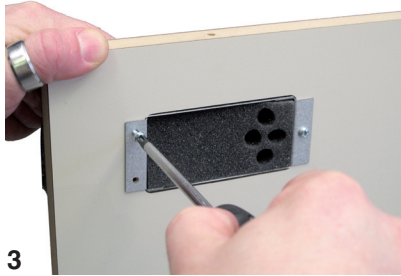
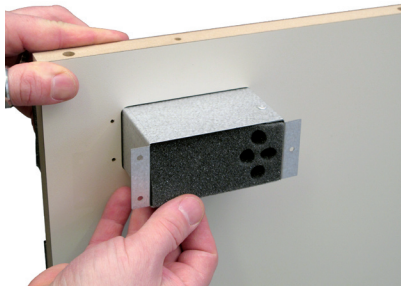
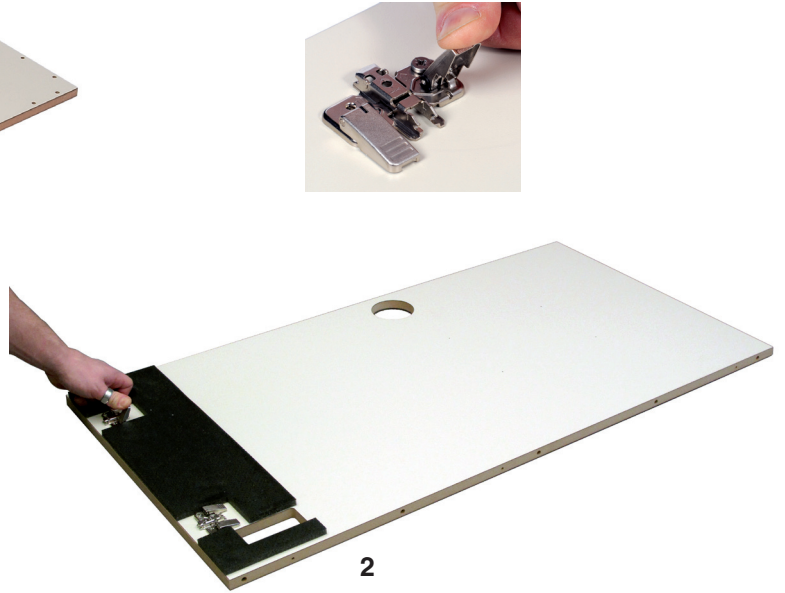
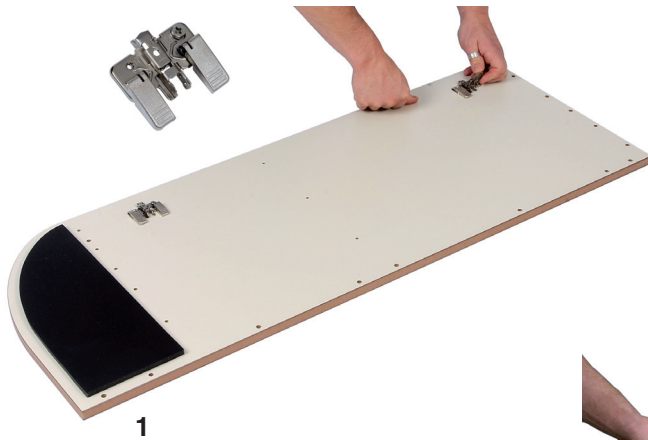

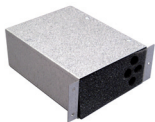

10404 (x1)



1293 (x7)



1505 (x12)



1510 (x20)



1555 (x1)



1545 (x4)



1553 (x2)



5



x12



x2



Basic Acoustic Cabinet. Art no: 2355



1550 (x1)

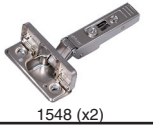

1548 (x2)



1

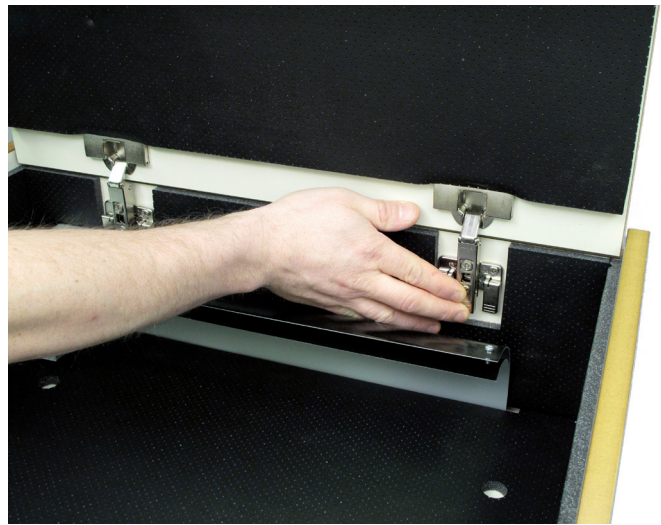

2



3



4



5

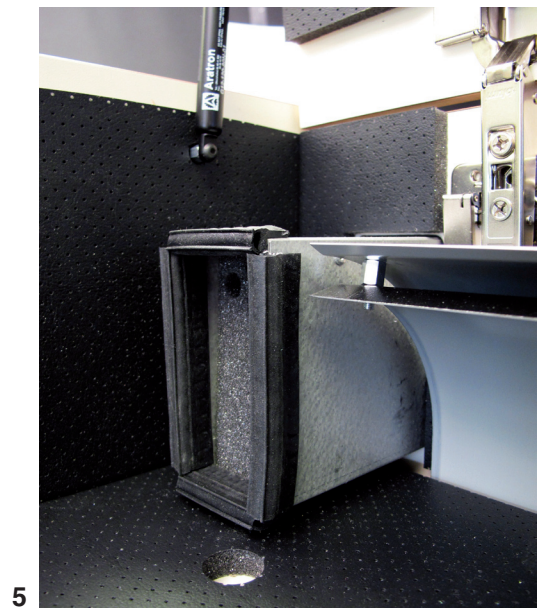



Acoustic Cabinet Everest v4/v3, Art no: 2375

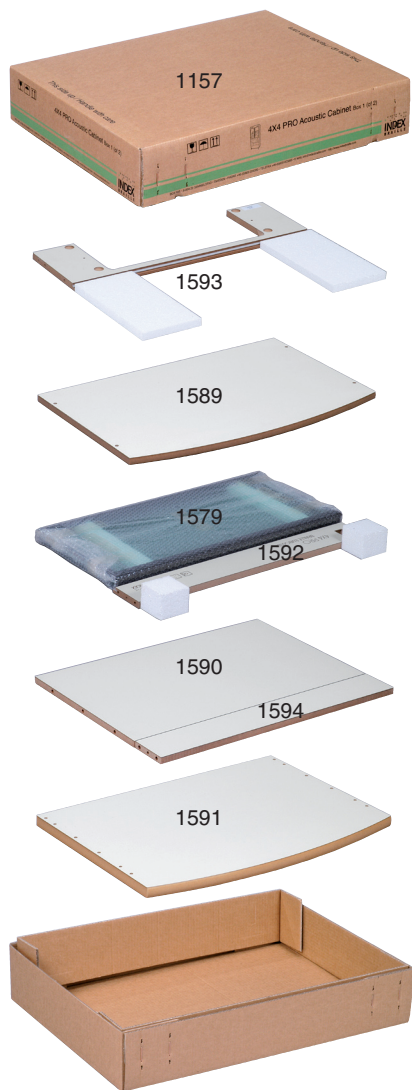

Box 1 of 2

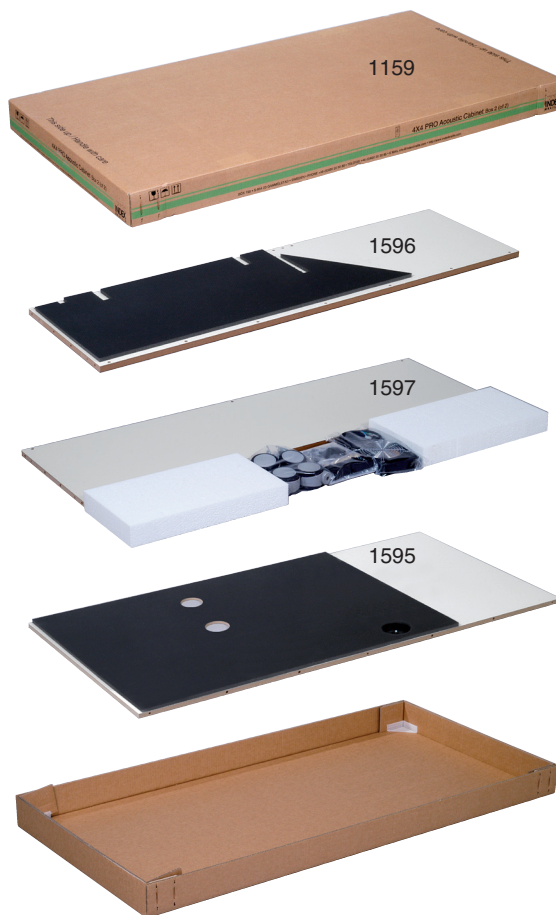

Box 2 of 2

Parts included



1582 (x8)



1801 (x8)



1505 (x18)



1058 (x16)



1795 (x16)



1794 (x16)



1509 (x44)



1581 (x1)



1585 (x4)



1556 (x1)



1586 (x4)



1587 (x4)



1799 (x4)



1600 (x2)



1599 (x2)

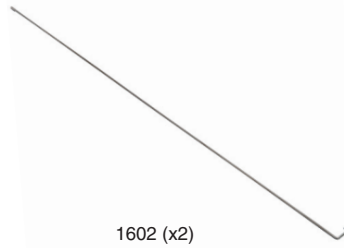

1602 (x2)



2031 (x1)



1273 Index Braille Stapler
(optional, not included)



Acoustic Cabinet Everest v4/v3, Art no: 2375



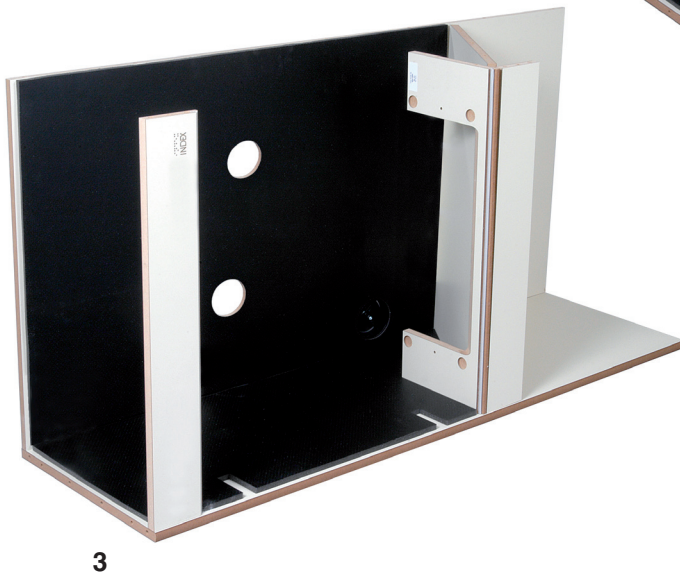
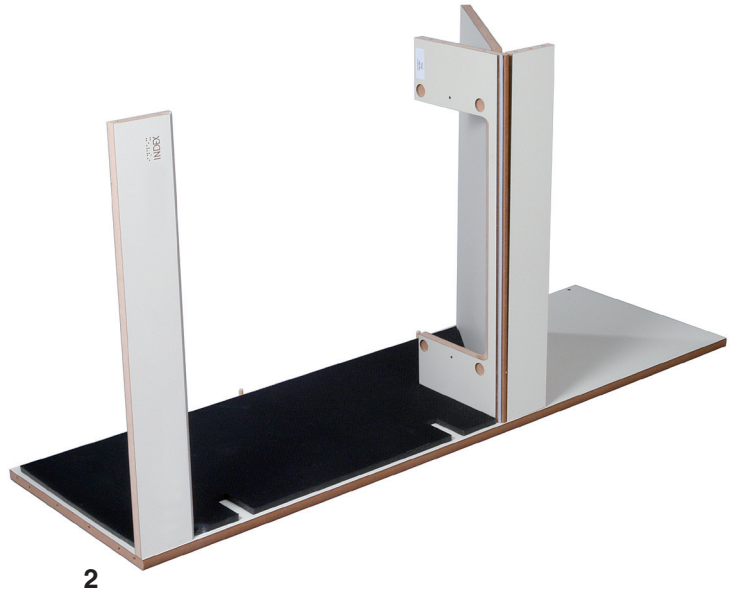
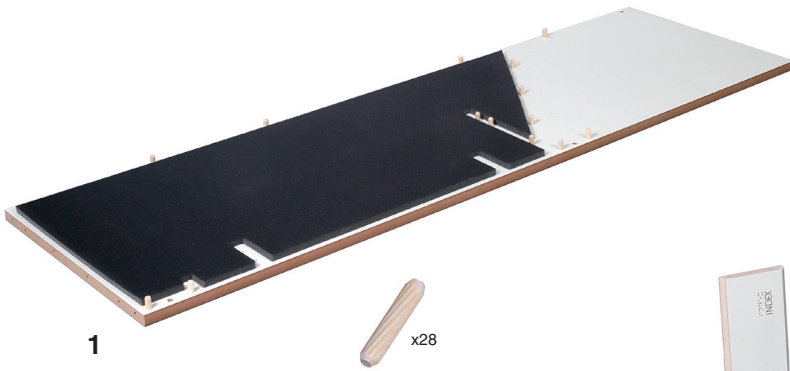
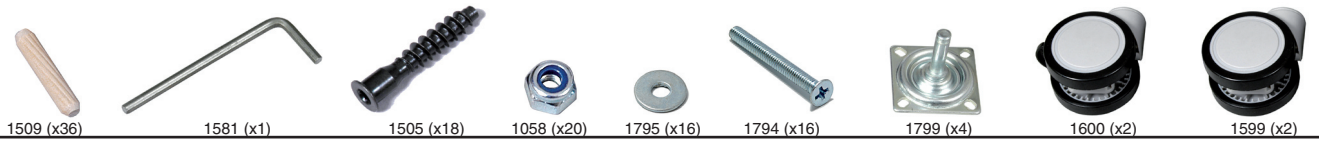





1509 (x8)



1505 (x8)

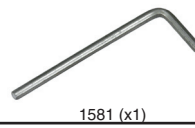

1581 (x1)



1801 (x8)

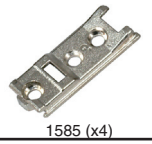

1585 (x4)



1



2



3

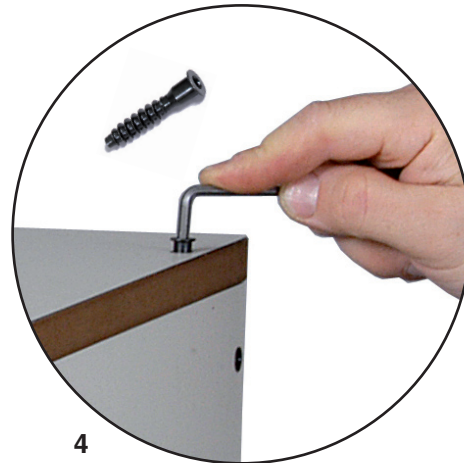

4



5





1582 (x8)



1586 (x4)



1587 (x4)

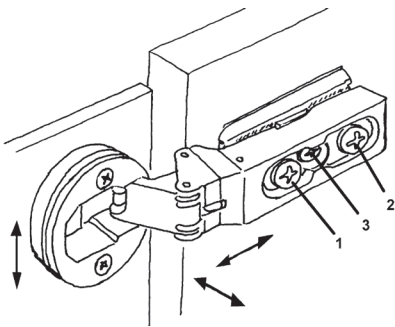

HINGE ADJUSTMENTS

1. Side adjustment +/- 2mm
2. Depth adjustment +/- 2mm
3. Height adjustment +/- 2mm



Acoustic Hood Basic. Art no: 1859

