

Acoustic hood/cabinet

Assembly instructions



Acoustic Cabinet Basic page 6
Art no: 1270



Acoustic Hood Everest page 2
Art no: 1250



Acoustic Cabinet 4X4 PRO page 14
Art no: 1314



Acoustic Hood Basic page 24
Art no: 1859

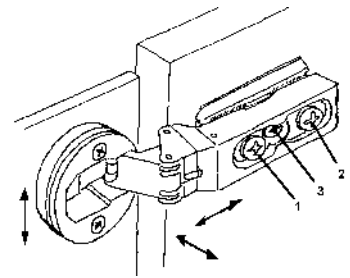
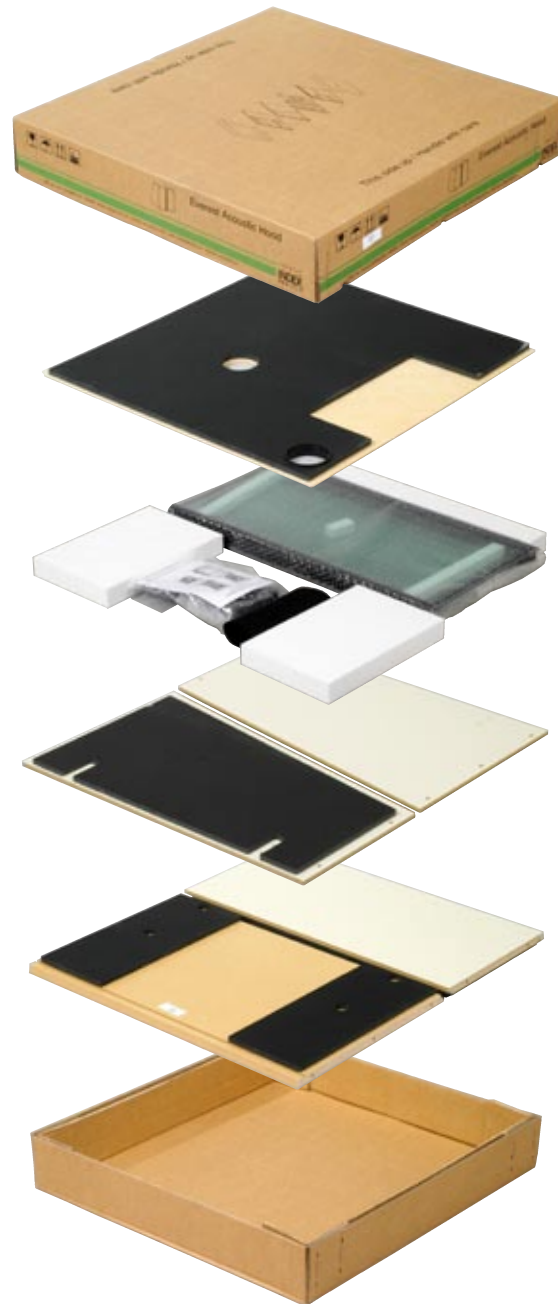

HINGE ADJUSTMENTS

- 1. Side adjustment +/- 2mm
- 2. Depth adjustment +/- 2mm
- 3. Height adjustment +/- 2mm

Parts included



1505 (x10)



1582 (x8)



1580 (x8)



1584 (x8)



1586 (x4)



1581 (x1)



2031 (x1)



1585 (x4)



1587 (x4)



1588 (x1)

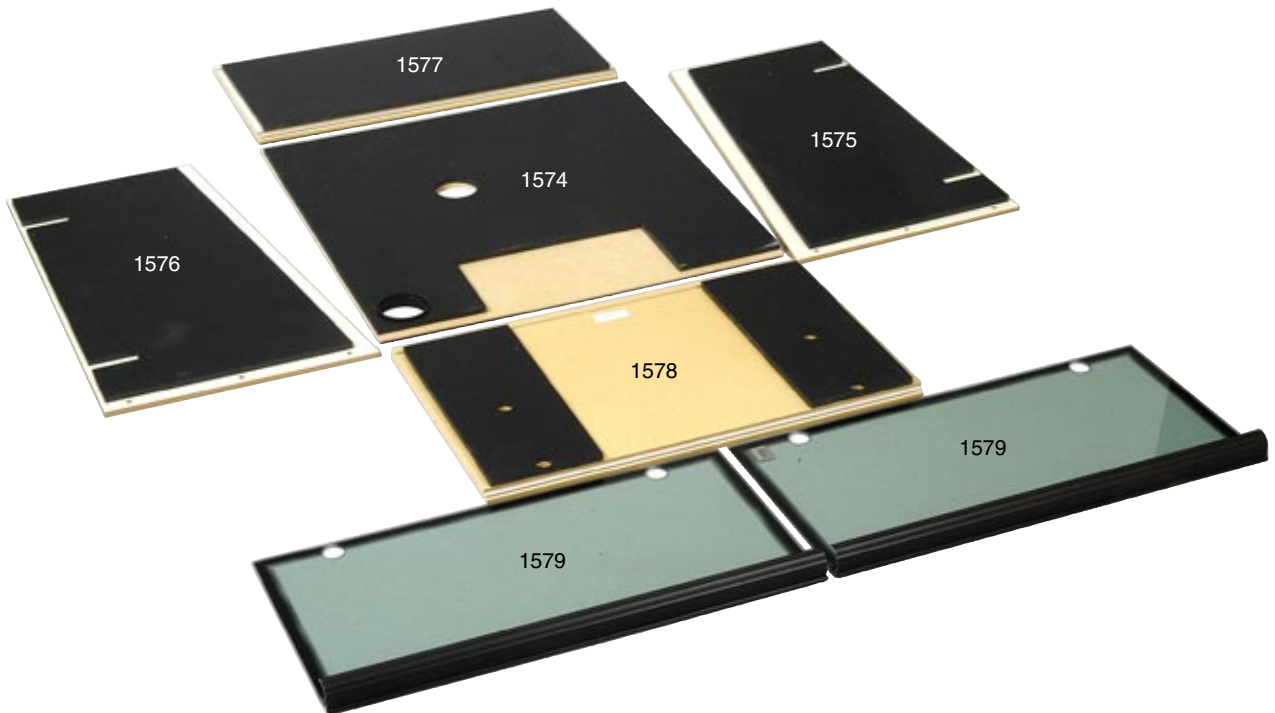



1



2



3



4



5



6

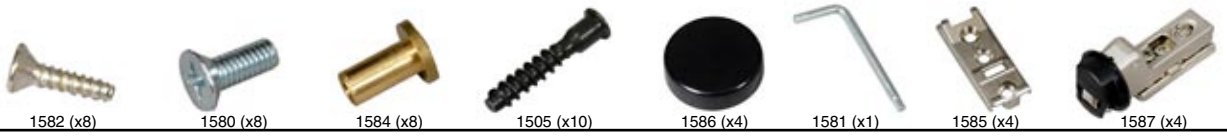

7



8



9



10



11



Basic Acoustic Cabinet. Art no: 1270



Box 1 of 2

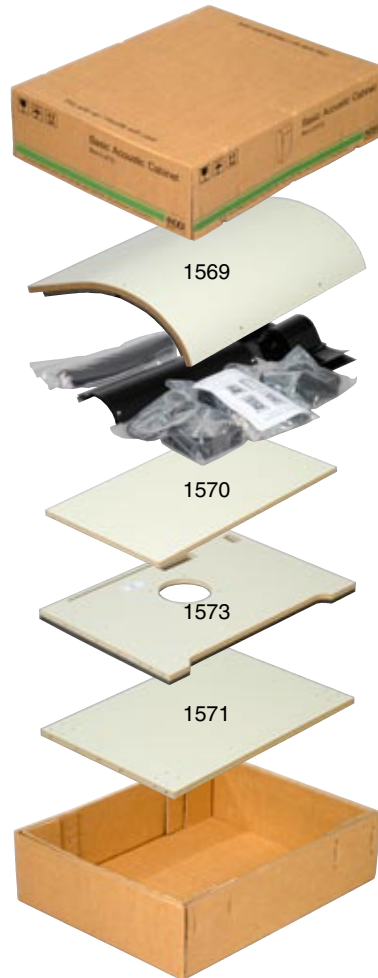

Box 2 of 2

Parts included

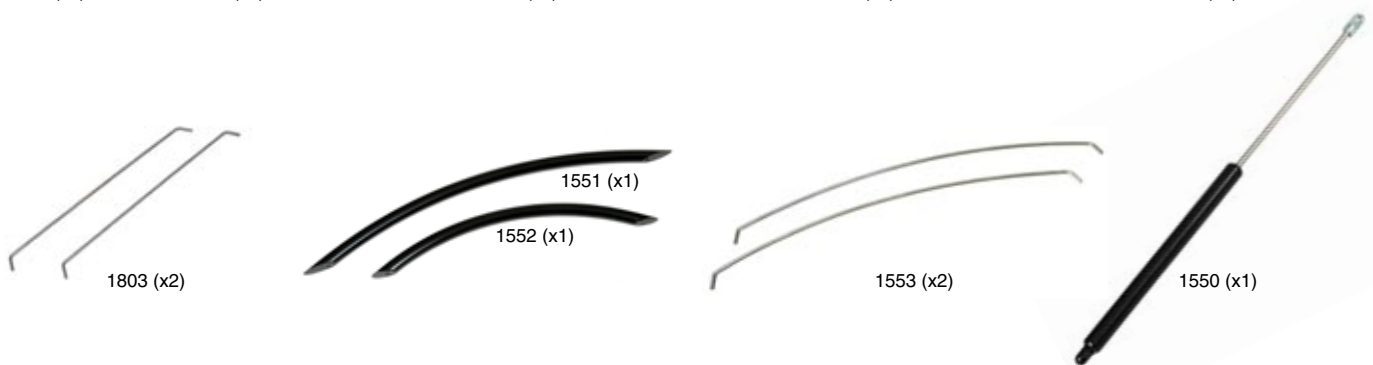
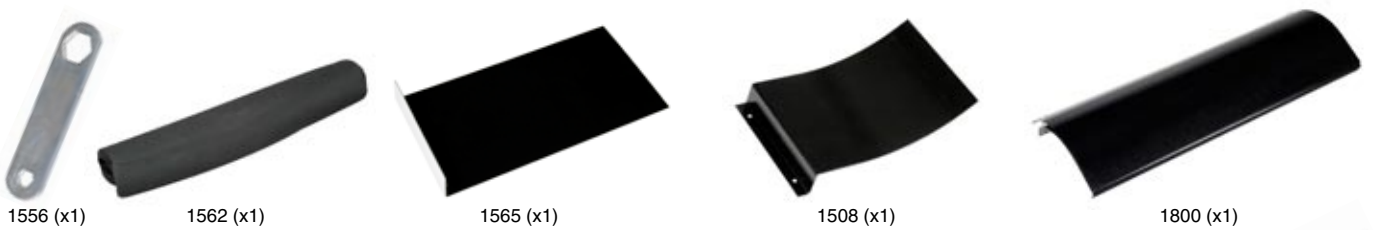
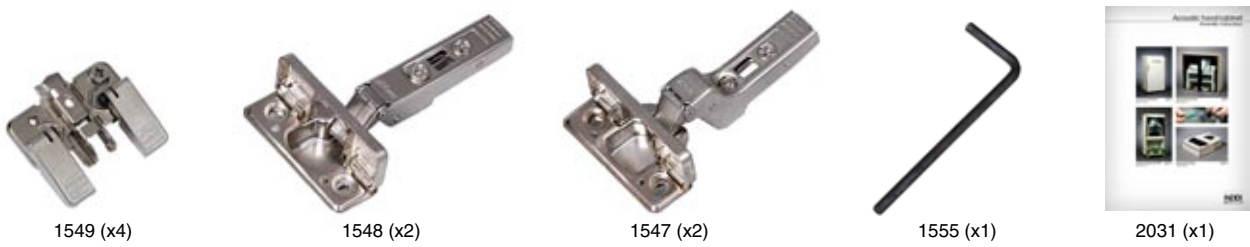



Basic Acoustic Cabinet. Art no: 1270



1



2



3



4

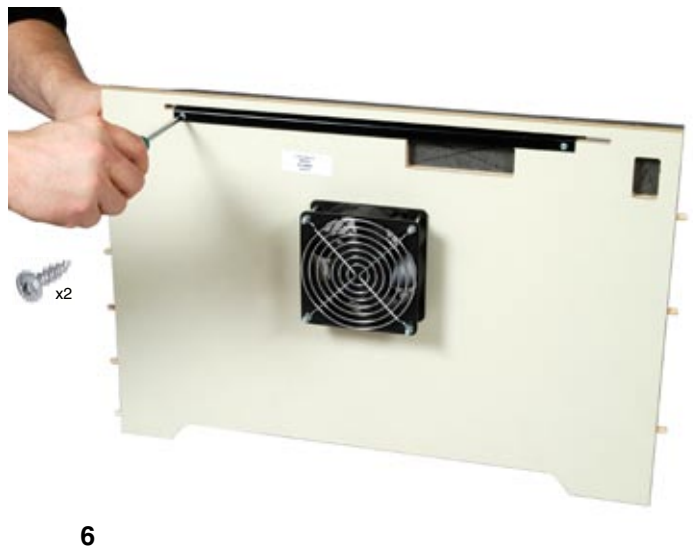
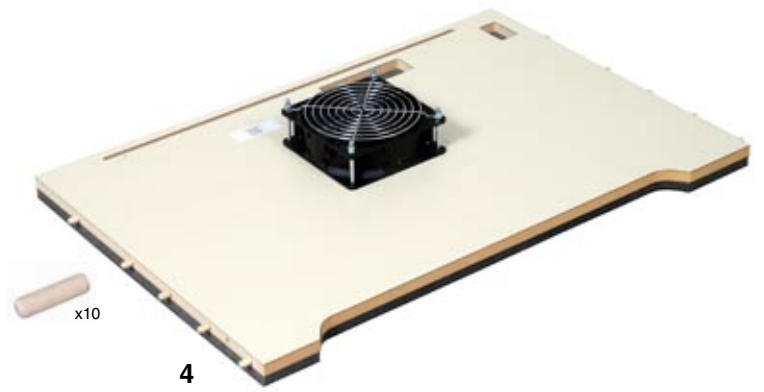
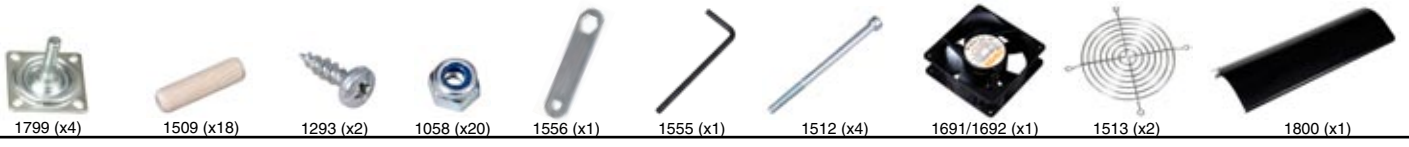



Basic Acoustic Cabinet. Art no: 1270

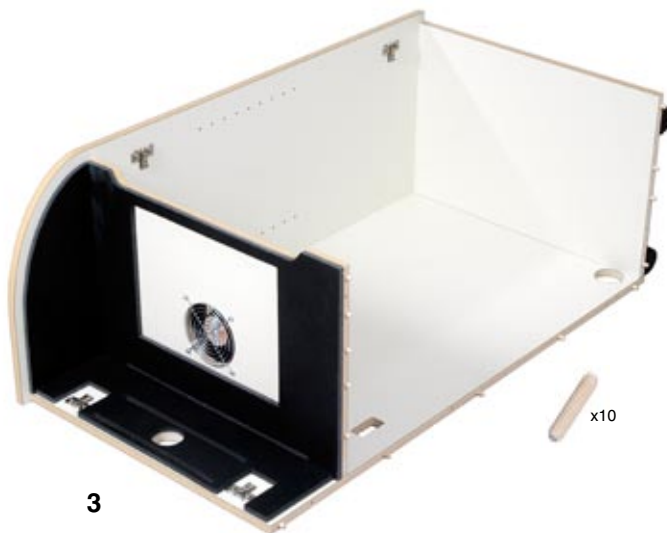
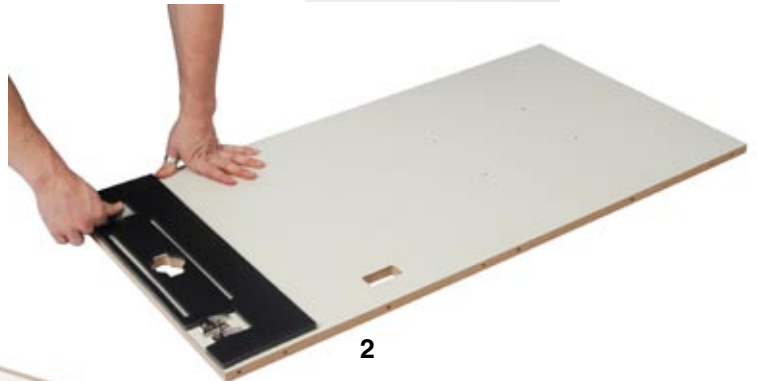
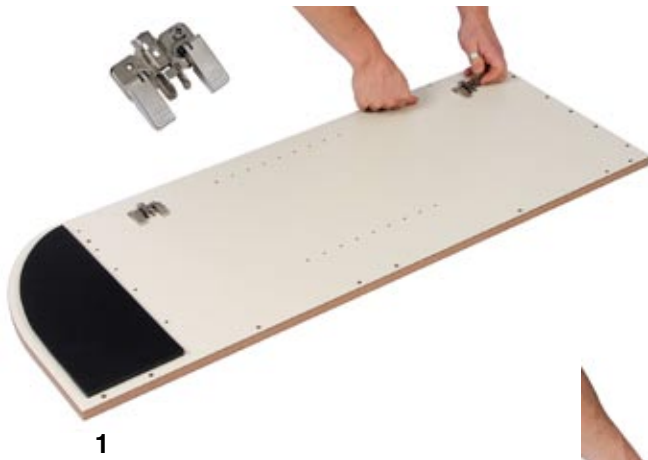



1505 (x12)



1510 (x10)



1555 (x1)



1518 (x4)



1545 (x4)



1553 (x2)



1



2



3



4



Basic Acoustic Cabinet. Art no: 1270



1



2



3



4



5



1



2



3



4



5



6

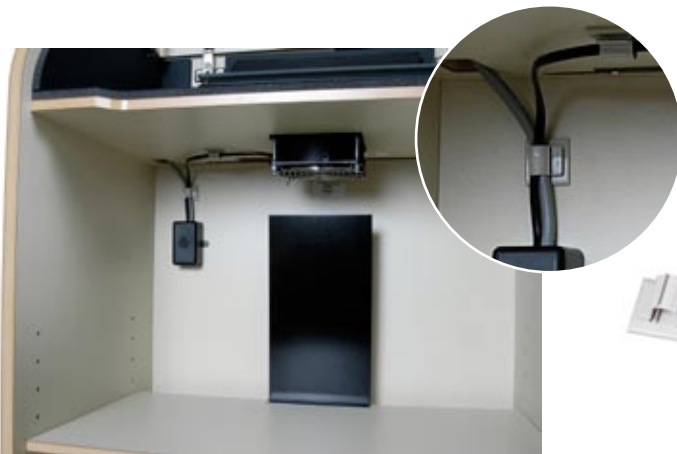

7

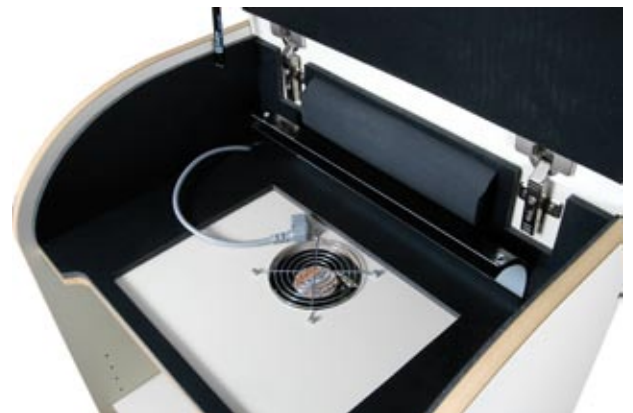

8



4X4 PRO Acoustic Cabinet. Art no: 1314

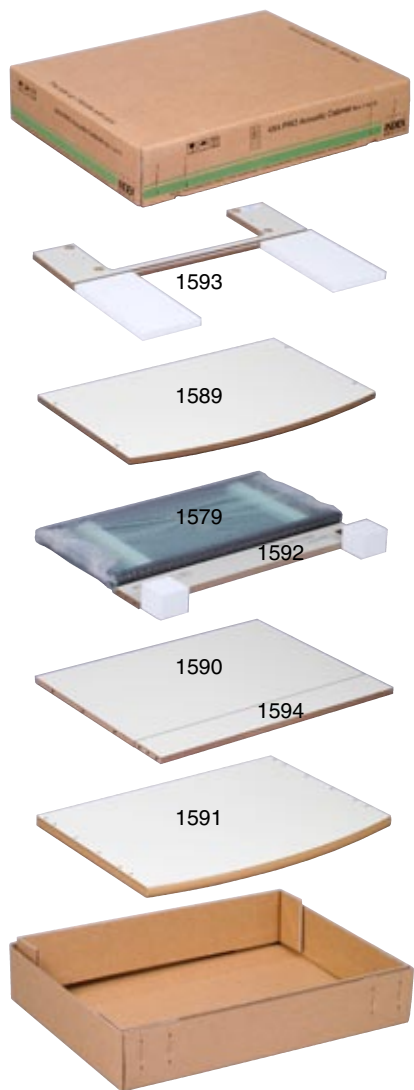

Box 1 of 2



Box 2 of 2

Parts included

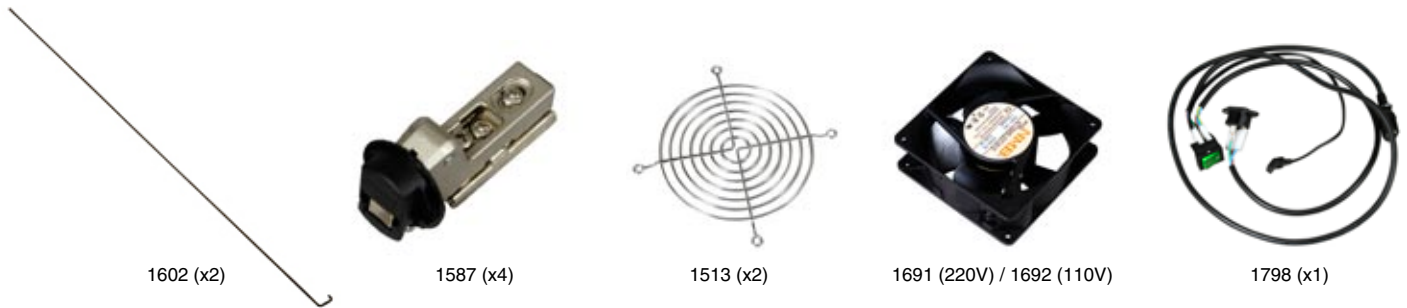

1273 Index Braille Stapler
(optional, not included)



4X4 PRO Acoustic Cabinet. Art no: 1314







4X4 PRO Acoustic Cabinet. Art no: 1314



2



3



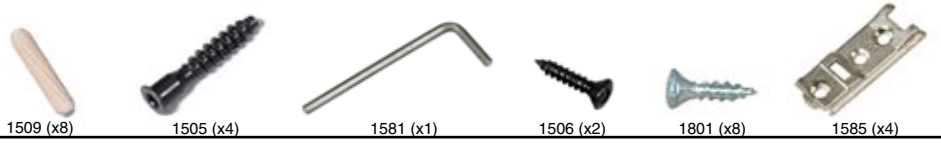

1



2



3



4



5

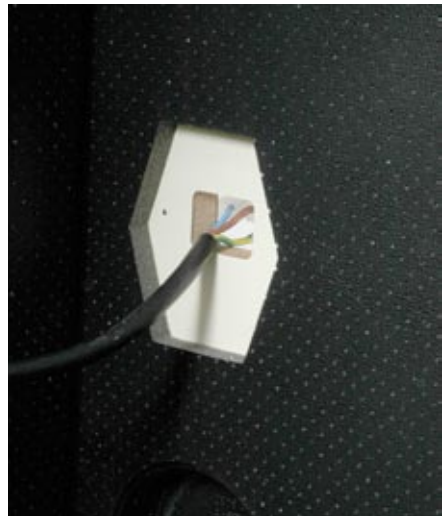

6



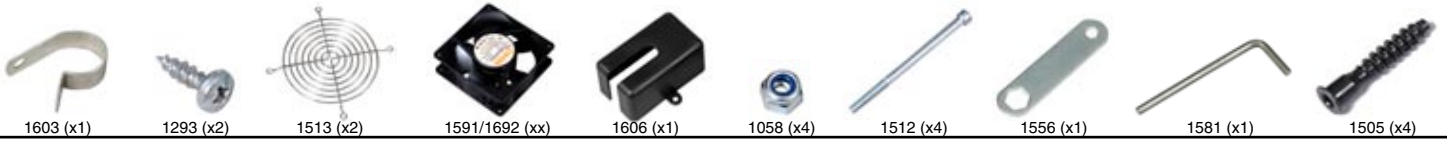



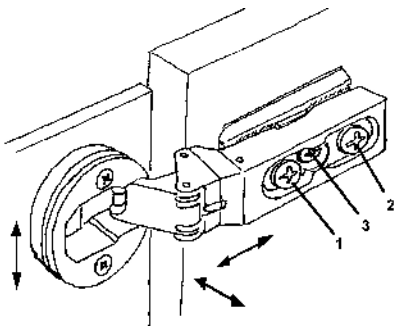

HINGE ADJUSTMENTS

- 1. Side adjustment +/- 2mm
- 2. Depth adjustment +/- 2mm
- 3. Height adjustment +/- 2mm



